

Frontal condensation hood

Product Manual

Installation, use and maintenance



INDEX

- 1. INTRODUCTION 3**
- 2. TECHNICAL CHARACTERISTICS..... 4**
 - 2.1. Main characteristics 4
- 3. GENERAL SAFETY AND ACCIDENT PREVENTION REGULATIONS 5**
 - 3.1. Personnel responsible for using the equipment..... 5
 - 3.2. Electrical hazard 5
 - 3.3. Thermal hazard..... 5
- 4. RECEPTION, TRANSPORT AND POSITIONING 6**
 - 4.1. Reception..... 6
 - 4.2. Transport..... 6
- 5. INSTALLATION 7**
 - 5.1. Positioning 7
 - 5.2. Electrical connection 10
 - 5.3. Drain connection..... 12
- 6. HOOD OPERATION 14**
 - 6.1. Turning on the equipment..... 14
- 7. MAINTENANCE 15**
 - 7.1. Cleaning..... 15
 - 7.2. Owner liability 18

1. INTRODUCTION

This manual has been carefully prepared and reviewed to provide reliable information and assistance for proper installation, use, and maintenance that will ensure proper operation and prolong the life of the oven. This manual is divided into two parts, the first part dedicated to the installation of the equipment at the working point, and the second part focused on the operation and maintenance of the equipment.



Before any intervention or use of the equipment, it is necessary to read this manual carefully and completely.

The manufacturer declines all implicit or explicit responsibility for any errors or omissions it may contain.

- The equipment may not be used by personnel who do not have the necessary skills or experience for the proper functioning of the equipment. Do not let children use or play with the equipment.
- The owner of the equipment is obliged to have this manual read by personnel responsible for its use and maintenance and to keep this manual in a safe place for use by all users of the equipment and for future reference. If the equipment is sold to others, they must be given this manual.
- This equipment must only be used for its intended purpose, i.e., steam condensation from a Mychef oven. Any other use can be dangerous and can result in personal injury and property damage. The manufacturer declines all responsibility in case of its use with other machinery or for purposes not described in this manual.
- The equipment is shipped from the factory once it has been calibrated and has passed rigorous quality and safety tests that ensure its correct operation.



The manufacturer will disclaim any responsibility for problems caused by improper installation, modification, use or maintenance.

2. TECHNICAL CHARACTERISTICS

2.1. Main characteristics

	MYCHA268	MYCHA270
Exterior dimensions (Width x Depth x Height) (mm)	620 x 750 x 155	760 x 760 x 155
Electrical connection	230 V / L+N / 50-60 Hz	
Total Power (W)	380	

Table 1. Main characteristics for the Steam condensation hood for Mychef ovens

3. GENERAL SAFETY AND ACCIDENT PREVENTION REGULATIONS

3.1. Personnel responsible for using the equipment

The use of the equipment is reserved for trained personnel.



Personnel who perform any action on the oven, such as operation, cleaning, installation, handling, etc., must be familiar with the safety regulations and the Operating Instructions.



Do not allow unauthorized personnel to use, handle or clean the equipment.

3.2. Electrical hazard

Work on the electrical supply side and access to live parts may only be carried out by qualified personnel under their own responsibility. In any case, such access must be made with the equipment disconnected from the power supply.

3.3. Thermal hazard



Keep the ventilation openings free of obstacles. Do not install the equipment in the vicinity of flammable products.

4. RECEPTION, TRANSPORT AND POSITIONING

Before carrying out the installation, they must verify the electrical characteristics of the equipment and make sure that they coincide with the characteristics of the electrical installation of the building. This equipment has an outlet pipe for the water resulting from condensation, so a nearby drain must be available to lead the condensation water to it.

4.1. Reception

Once the oven has been received, check that the model purchased corresponds to the order.

Check that the packaging has not been damaged during transport and that no parts of the equipment are missing. If you detect any anomaly or problem, contact your dealer immediately.

4.2. Transport

The equipment should be transported in its original packaging to the closest location to the point of installation to avoid damage as much as possible. It is recommended to keep the original packaging until the equipment is properly installed and in operation.

To move the equipment and place it in your workspace, the following observations should be taken into account:

- The handling must be done with the necessary personnel to move the load of the furniture taking into account the current occupational safety regulations at the place of installation.
- Make sure that during transport it does not tip over and is not hit by any object.

5. INSTALLATION

Before starting the installation, remove the protective film. Slowly peel off the protective film from the equipment, clean the glue residue with a suitable solvent, without using tools that can damage the surfaces or acid detergents or abrasives.

5.1. Positioning

Once the equipment has been unpacked, place the hood on the Mychef oven.

Step 1 → Unscrew the rear screws to separate the rear cover from the hood.

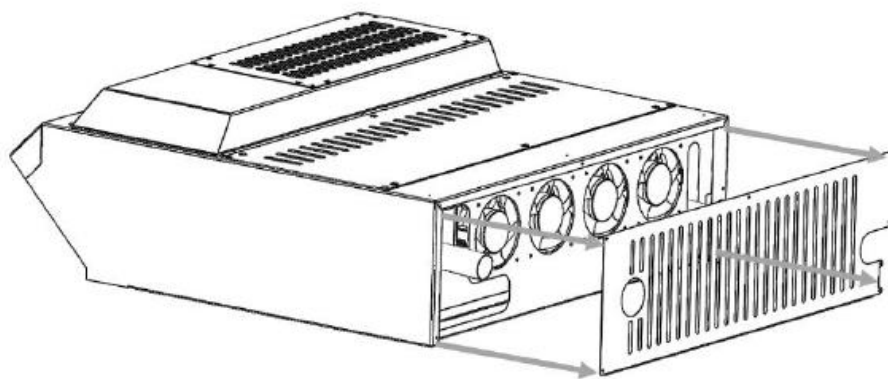

Figure 1. Rear cover removal

Step 2 → On the front part of the hood, cut the opening through the slot to facilitate fitting to the fixed side of the door.

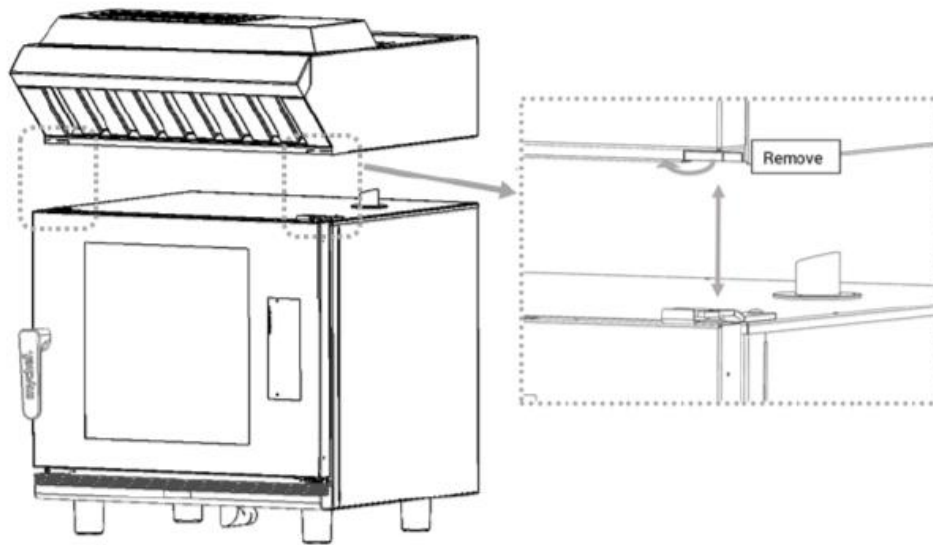

Figure 2. Fit of the hood on the front

Step 3 → Position the hood on the oven, flush with the sides and at the back so that the chimney of the Mychef oven coincides with the inlet hole located at the bottom of the condensation hood.

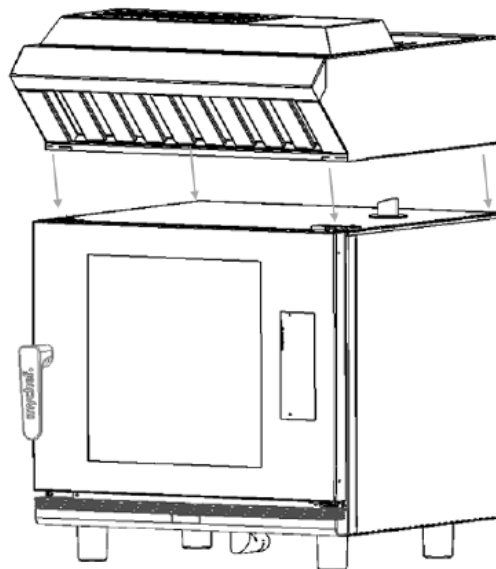

Figure 3. Positioning of the condensation hood

Step 4 → Connect the hood tube to the chimney and place the flange.

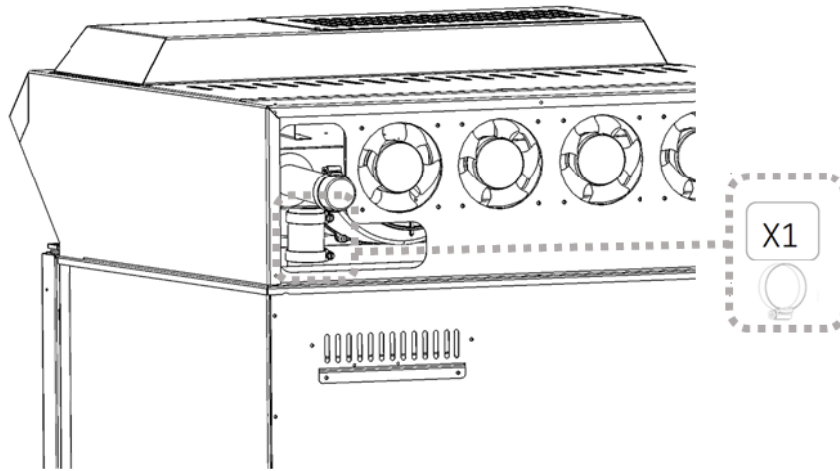

Figure 4. Flange assembly

Step 5 → Screw the hood rear cover.

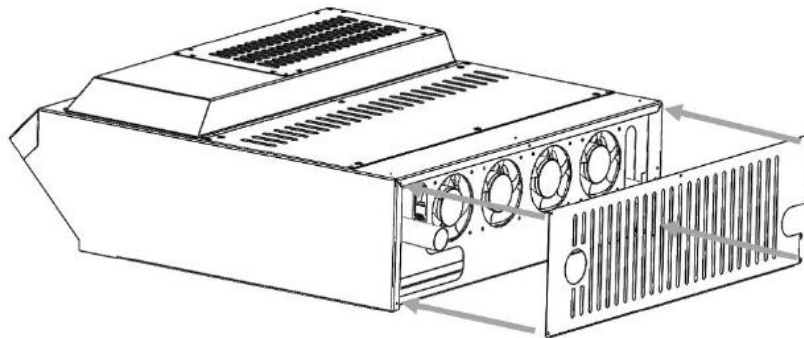

Figure 5. Screwing rear cover



Keep all ventilation openings clear of obstacles.

In case of mounting the hood on several stacked Mychef ovens, the chimney of the lower unit must be channelled and connected to the rear inlet of the condensing hood. To do this, remove the plastic plug provided in the hood inlet and make the connection using a 40mm inner \varnothing tube. See following picture for reference.

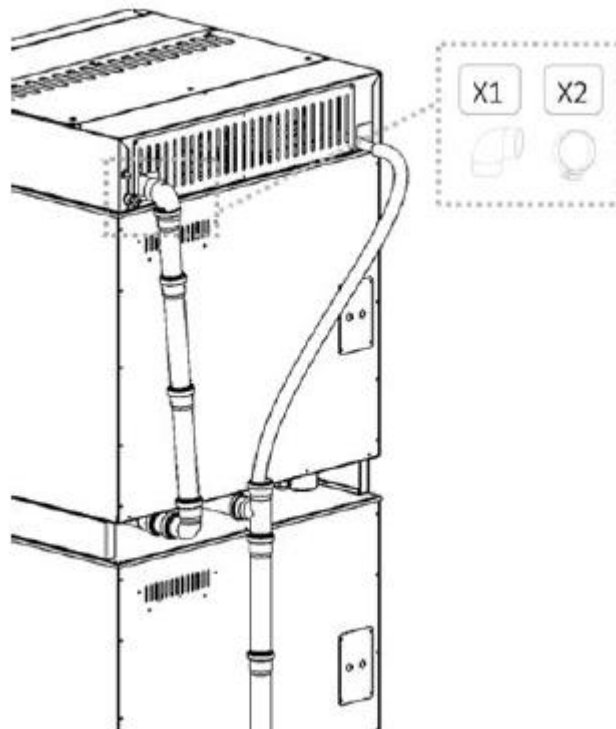

Figure 6. Hood connection in stacked ovens

5.2. Electrical connection

Check that the voltage that reaches the point where the oven is going to be connected coincides with the operating voltage of the equipment.

Before carrying out any electrical work, check that no electrical current is reaching the equipment connection point.

Ensure an effective ground connection in all cases.

The wiring and other safety devices used for the electrical installation must have the appropriate cross-section for the equipment in question.

Step 1 → Remove the rear cover of the oven for the electrical connection.

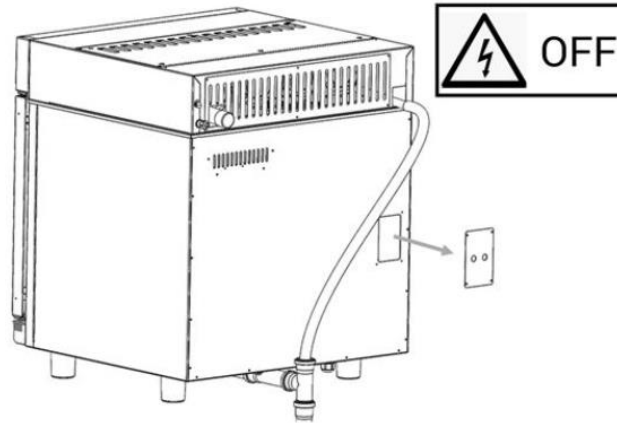

Figure 7. Rear cover of the oven

Step 2 → Insert the cable gland and connect the communication cable.

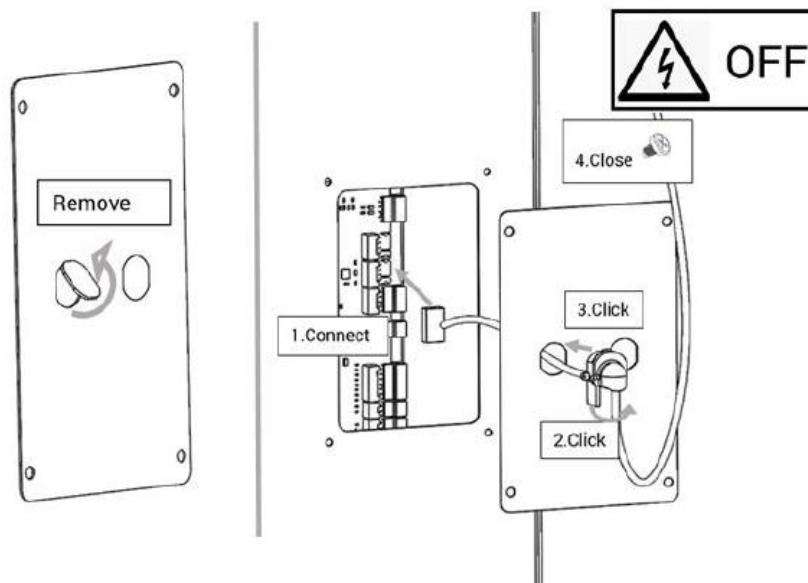

Figure 8. Electrical assembly

Step 3 → Connection of the hood to the electrical network.

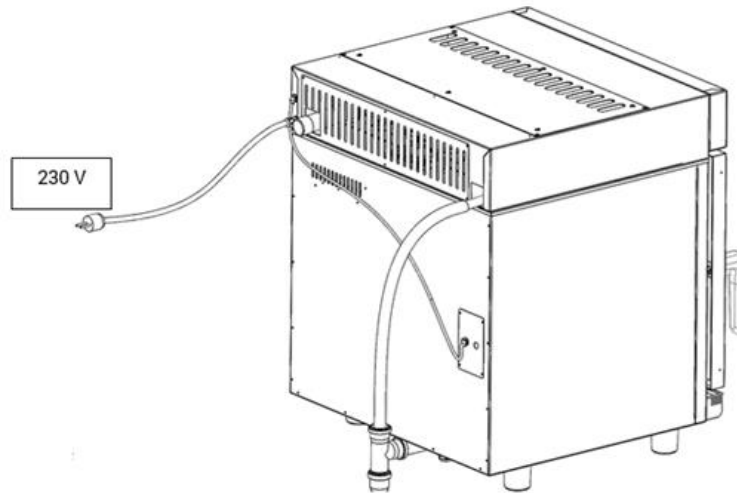

Figure 9. Electrical connection

Verify, once the connection is made, that no cables are loose and that they are all firmly attached.



In any case, respect the current regulations for connecting the equipment to the low voltage network.

5.3. Drain connection

The condensation hood is a device that collects the water vapor from the oven that comes out through the chimney and condenses it, eliminating the condensation water through a drain pipe.

This tube is located on the back of the equipment.

Connect the drain hose with a flange.

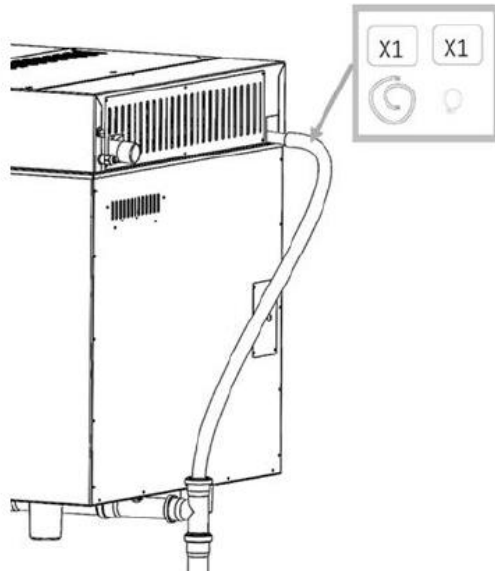

Figure 10. Drain connection

Connect said outlet with a drainage point of the building installation, using the flexible Ø20mm tube provided.

6. HOOD OPERATION

This hood has the function of condensing the steam that comes out of the oven chimney and sucking in through the front part when the oven door is opened.

The smoke evacuation can be direct to the environment with natural ventilation or through an existing extraction system at the installation site.

6.1. Turning on the equipment

The hood will automatically activate when the oven is turned on.

When the door is opened, the suction capacity at the front is increased.

7. MAINTENANCE



Before the appliance is handled for maintenance or repair, it should be disconnected from the electricity grid.



If the power cable is damaged, it should be replaced by its aftersales service or by personnel with similar qualifications in order to avoid danger.

7.1. Cleaning

To clean the outer casing, use a cloth dampened with water and dish soap or a specific stainless-steel cleaner. Then rinse and dry.

Cleaning of the hood must be done regularly in less than 12 months.

For meats and roasts, cleaning should be every 3 months; for confectionery every 6 months.



Cleaning the steam condensation hood with pressure cleaning equipment is harmful to the appliance and may cause the appliance to break, and it will void the warranty.

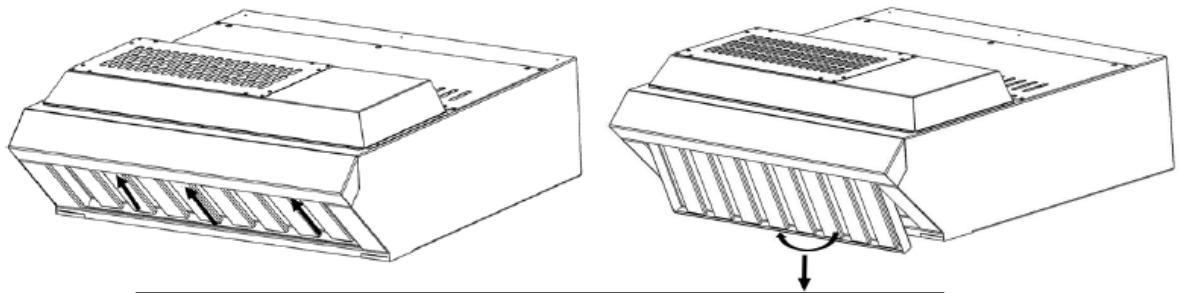

Degrease and rinse with water.
Or clean in a dishwasher

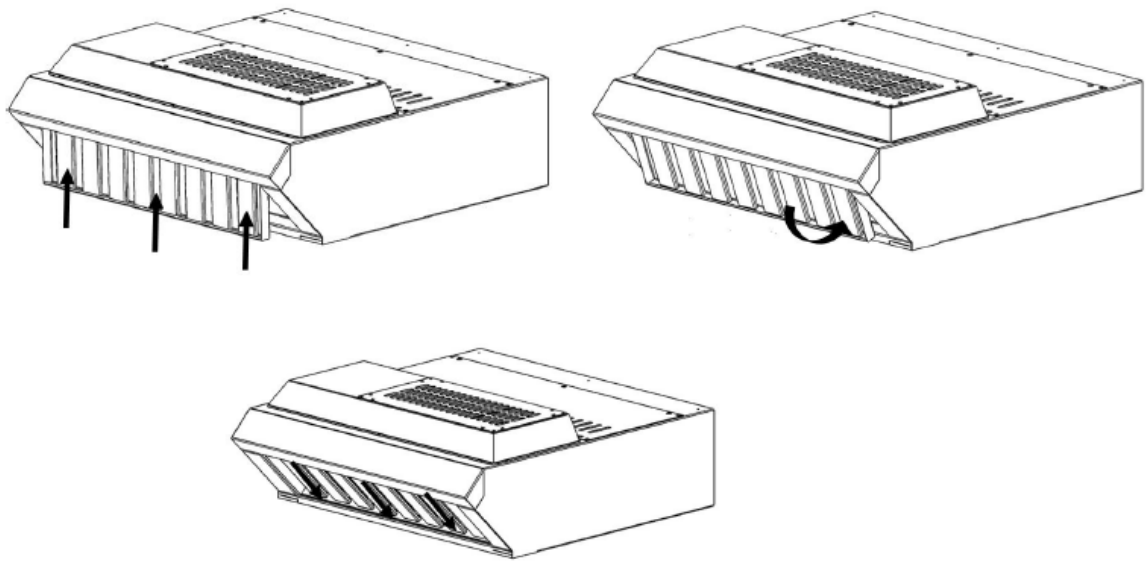

Figure 11. Cleaning with degreaser and rinsing with water

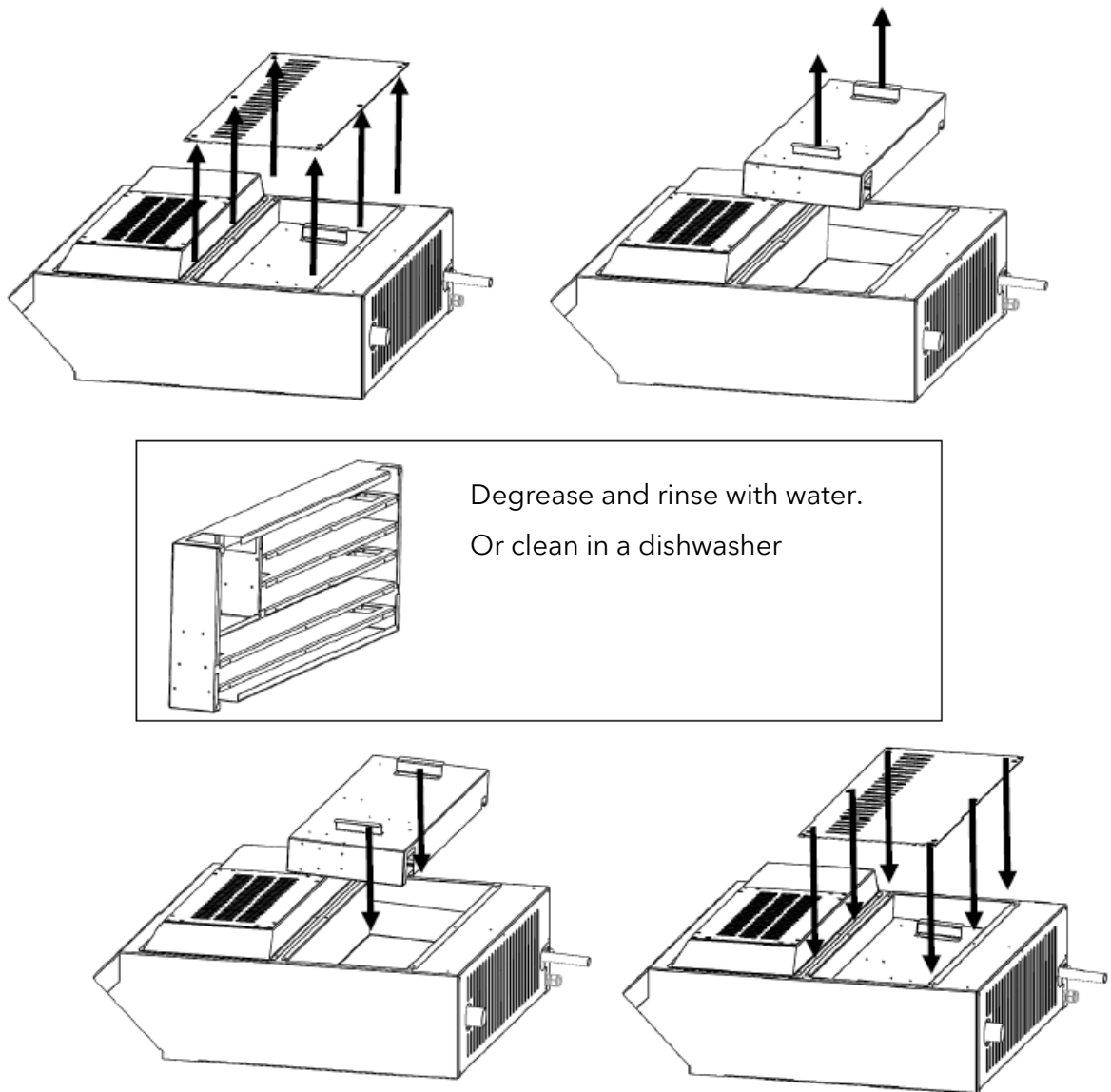

Figure 12. Cleaning with degreaser and rinsing with water

7.2. Owner liability

The owner is responsible for regular maintenance. To keep the warranty valid, the owner must prove that maintenance has been carried out correctly and following the detailed instructions in this manual.